

WHALEY PRODUCTS INC.

P.O. Box 817, BURKBURNETT, TX 76354

PH: 940-569-4116 FAX: 940-569-4247 WWW.WATERCHILLERSYSTEMS.COM



Air Cooled Portable Chiller Model SAP3-2-2PT



Made in the USA

Aerial View

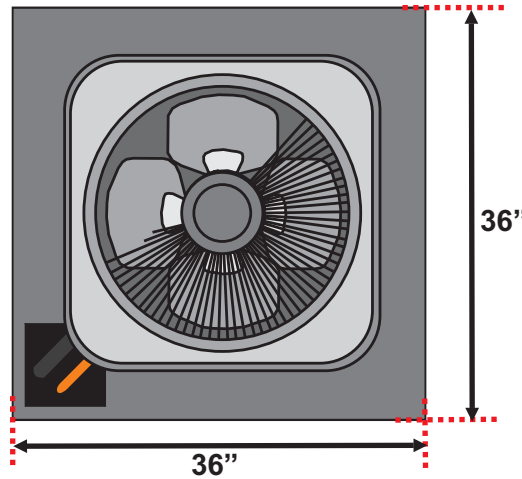

Model #: SAP3-2-2PT
Nominal Tons: 3 Ton
KW: 10.5
BTU/hr: 36,000
Pump Configuration: Dual
Voltage: 208-230/1
Unit FLA:31.9
Supply Pump HP: 1 HP
Circ Pump HP: 0.5 HP
Max Flow: 7.2 gpm
Insulated Poly Tank Size: 30gal
Length: 36"
Width: 36"
Height: 64"
Number of Compressors: 1
Inlet/Outlet Connections: 1"

Left Side View

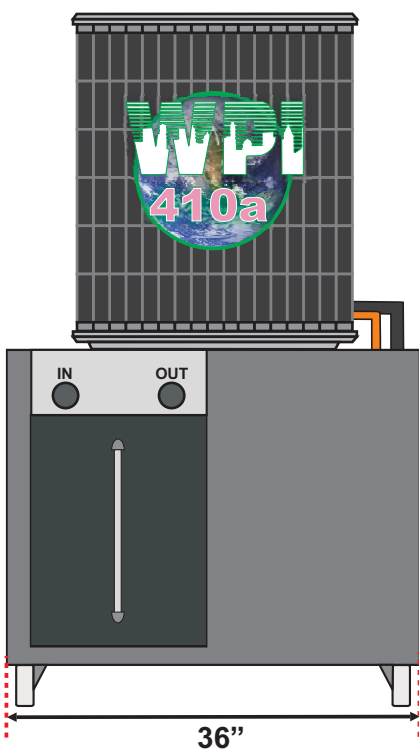

Front View

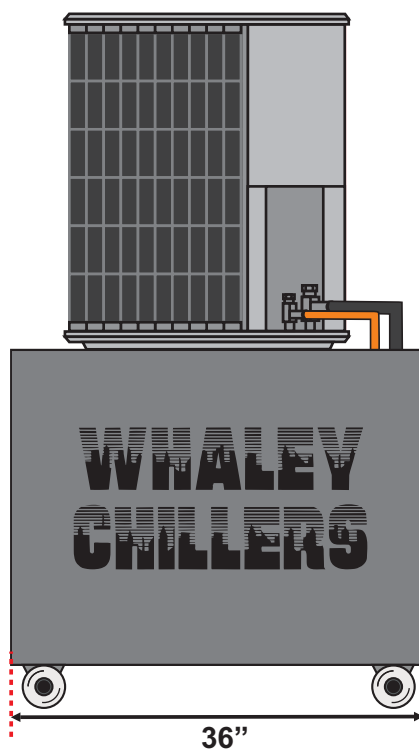

Right Side View

